



TIVOLI

ELECTRICAL VERSION

SWITCH CODE		
	NORMALLY OPEN CLOSED WHEN ENERGIZED	
	NORMALLY CLOSED OPEN WHEN ENERGIZED	
	MAKE AND BREAK SW.	

COLORS : PINK = PINK / YEL-YELLOW / GRAY = GRAY / GRN = GREEN
BLK = BLACK / BLU = BLUE / GRN = GREEN

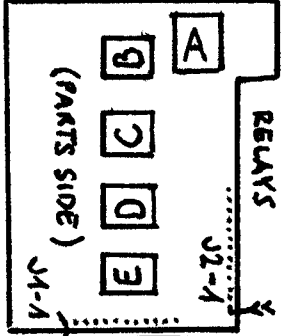
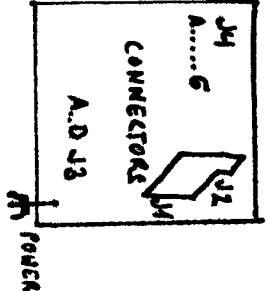

RELAY EXAMPLE

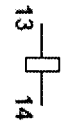
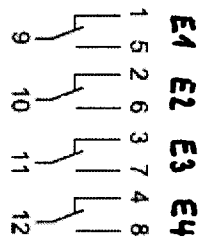

Copper side view

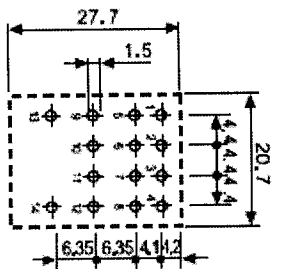

N
RED

J2-3

ATOS CAM COMMON (RED)

CAM3

LOWER SWITCHOFF

GRN/YEL

J1-7

A2

3

J2-5

YEL/BLU

LA RED

J2-2

PINK

RED (JUMPED)

CON. WIPER

START UPPER WIPER

WIPER

WIPER

START LOWER WIPER

REL. E

A

GRN
(JUMPERS)

TO SHEET 2 OF 4

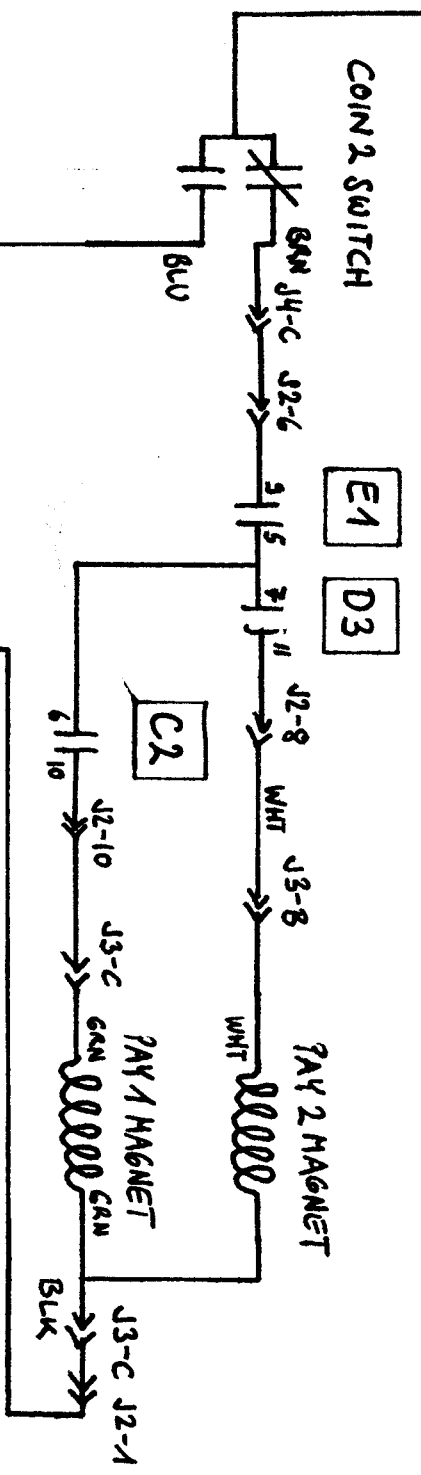
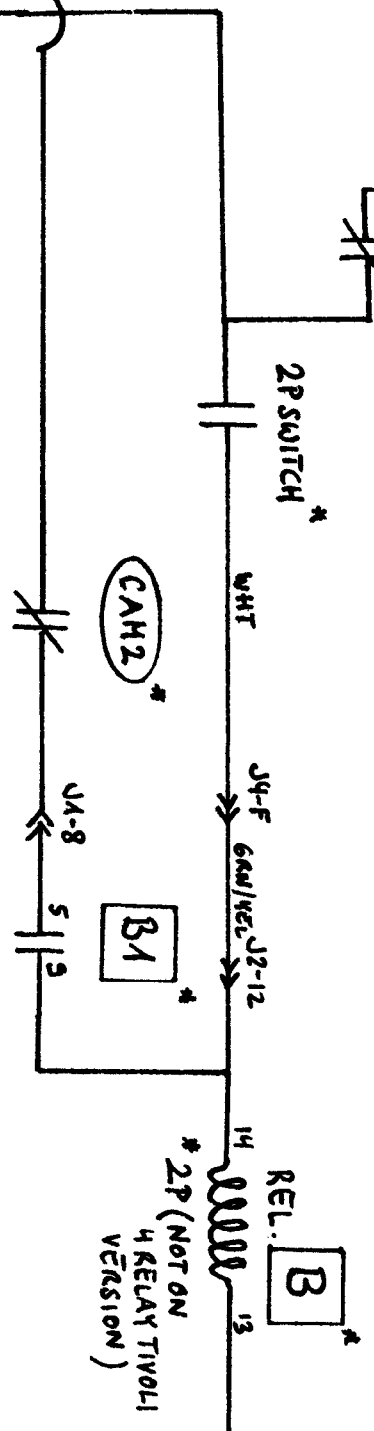
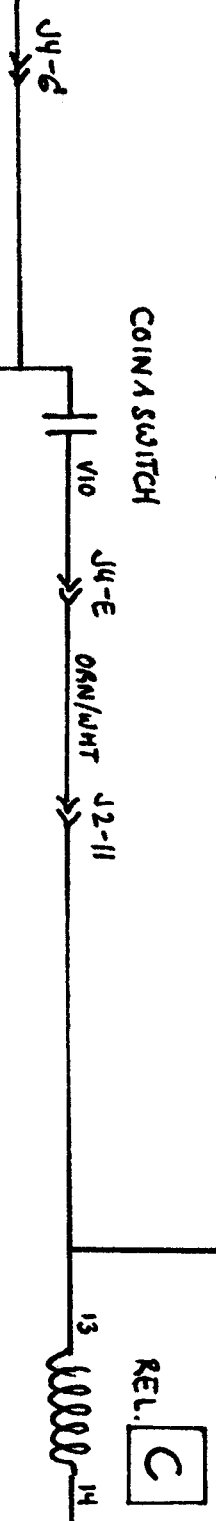
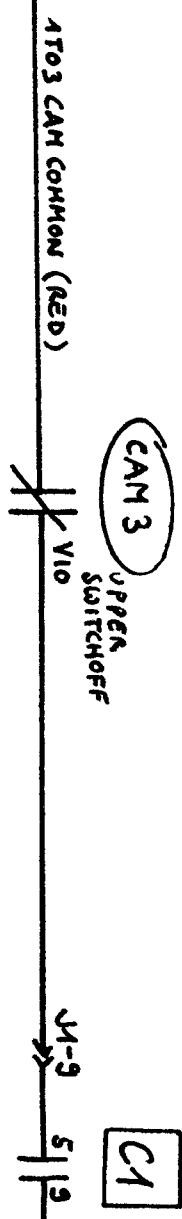

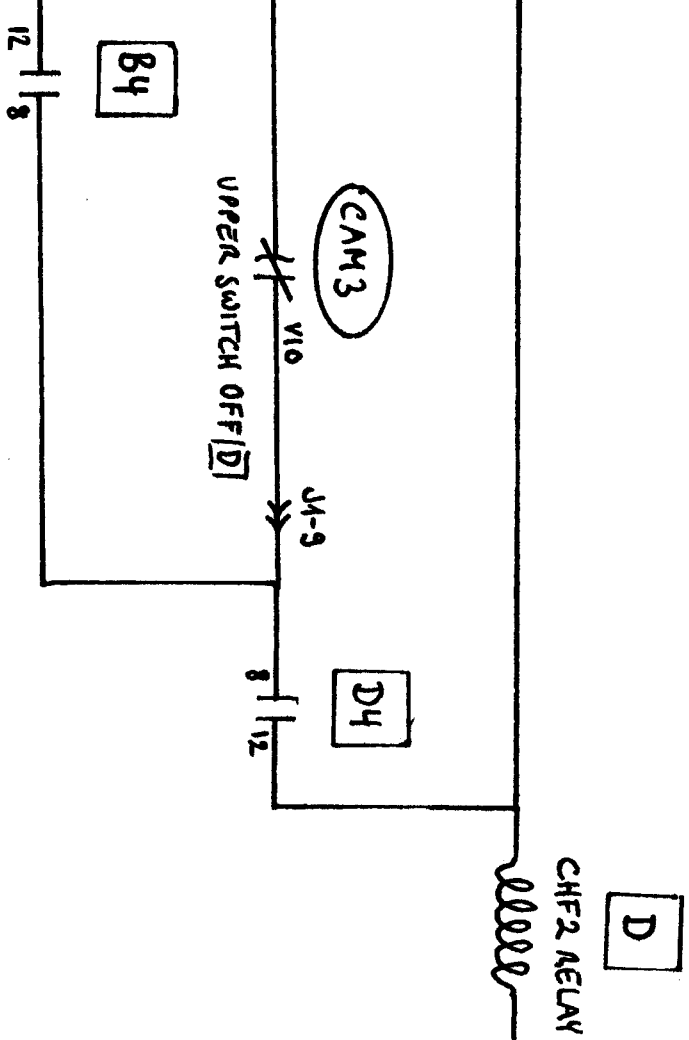
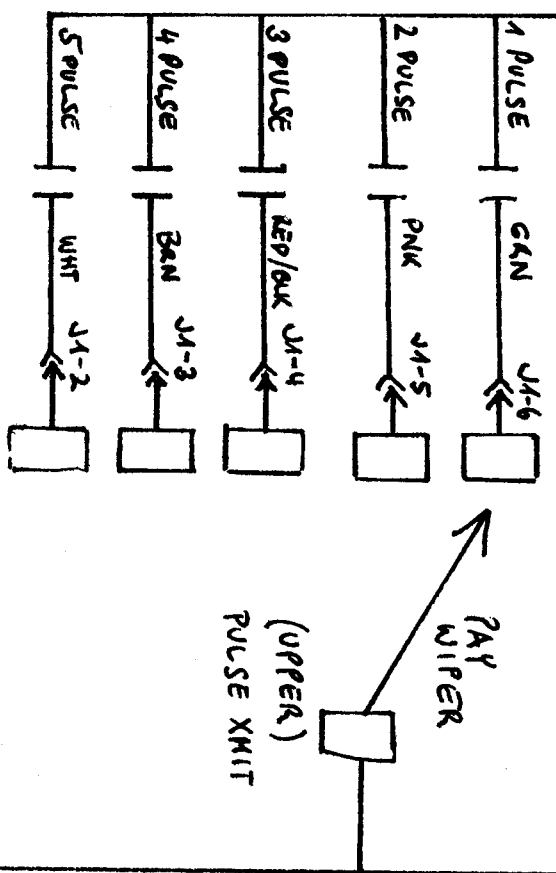

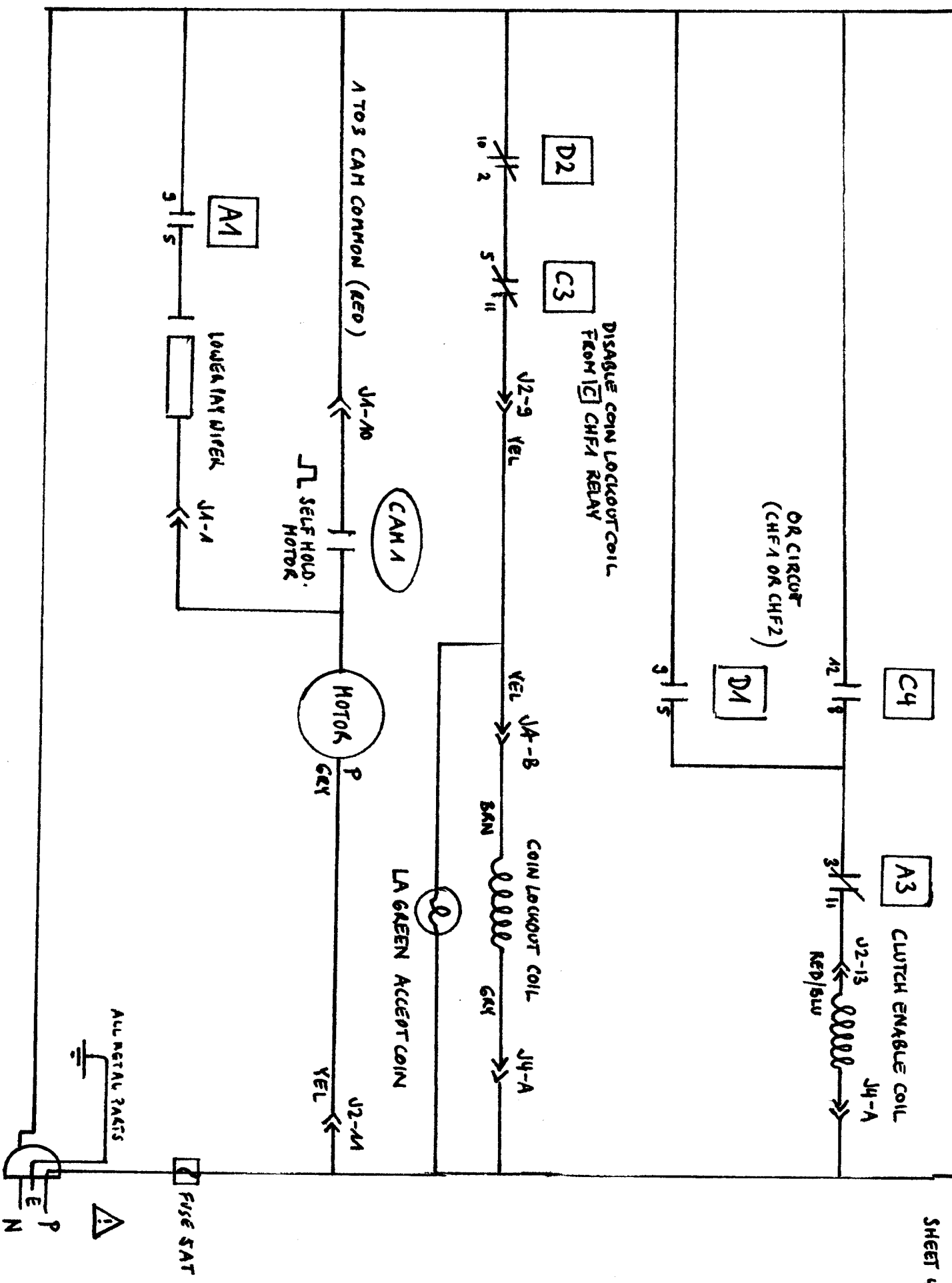

PLEASE REPORT ERRORS / COMMENTS TO : HANRUS.GOSTERNAYER.CH

THIS IS AN UNOFFICIAL DOCUMENT.
NO WARRANTY ACCEPTED REGARDING CORRECTNESS, COMPLETENESS,
SAFETY OF THIS DOCUMENT.